

## AP315G Fan Datasheet



### G-Series Durafan Chemical Resistant Fan Unit

The hard-working APMG Plastics Durafan G-Series general purpose fan is a robust and reliable forward curved multi-vane centrifugal fan unit. Manufactured from chemical resistant thermoplastic materials, it is recommended for light duty applications.

Tough and versatile, the G-Series delivers effective fume extraction and, while ideal for fume cupboards, is suited to countless other applications.

The fan is designed to extract and resist an extensive range of chemicals up to an operating temperature of 40°C. Check with our experienced sales team to ensure the G-Series' compatibility with your application.

Available in a choice of discharge angles, this durable model is suitable for both internal locations and external installation, typically on rooftops.

### AP315G Fan Characteristic Curve

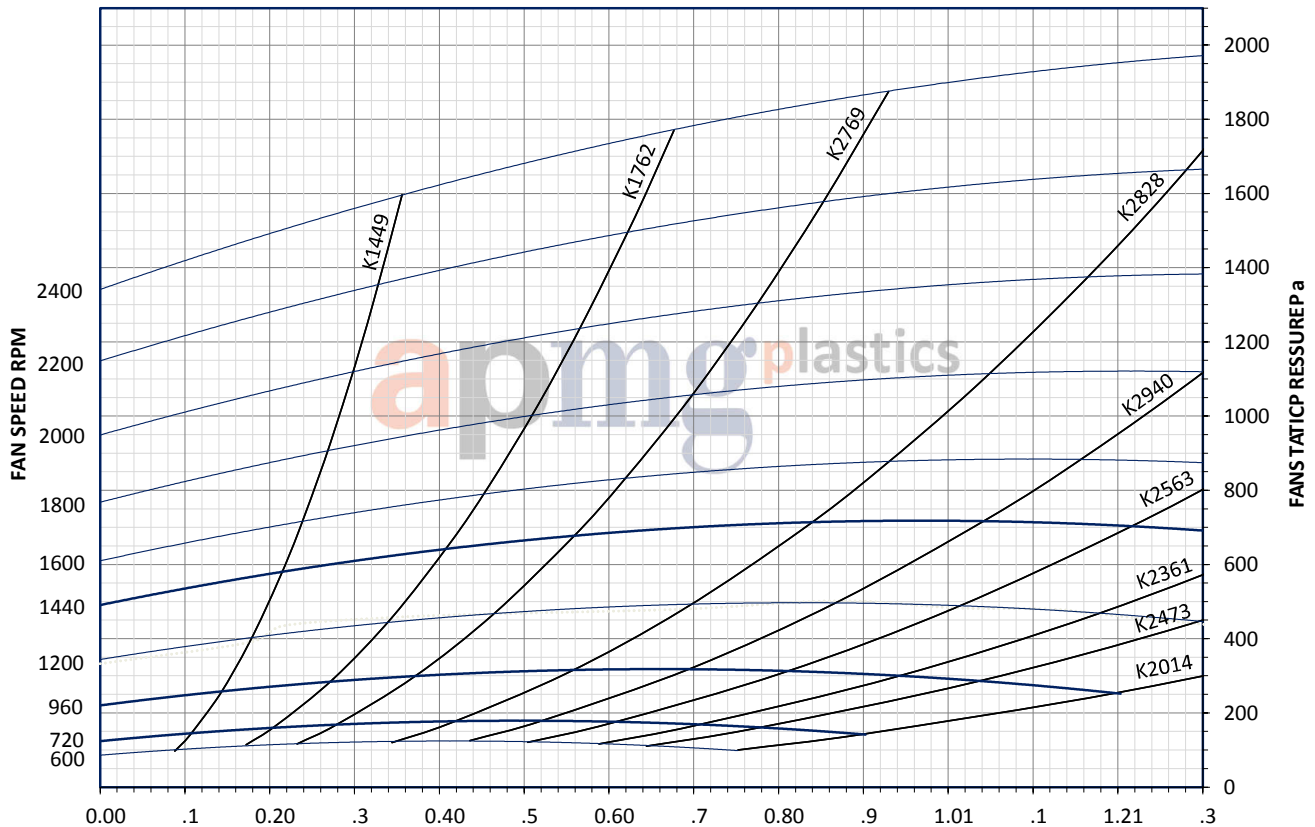

**To calculate the Power Absorbed**  
Plot the fan duty point onto the curves  
and interpolate the relevant 'K' factor.

Then

$$\text{kW} = \frac{6.35 \times \text{m}^3/\text{s} \times \text{Pa}}{\text{K}}$$

To compensate for belt and bearing  
loss multiply the result by 1.2.

# AP315G Fan Datasheet

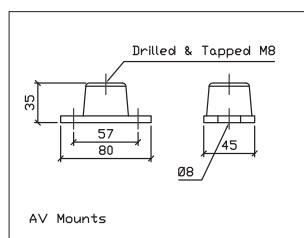
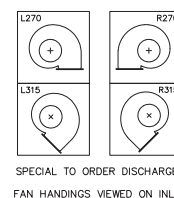
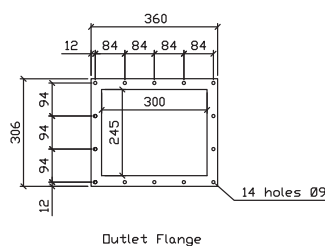
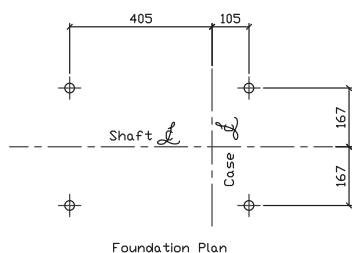
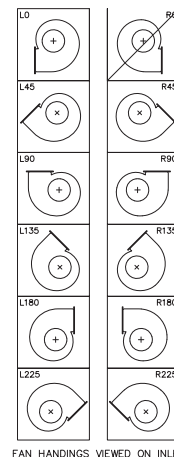
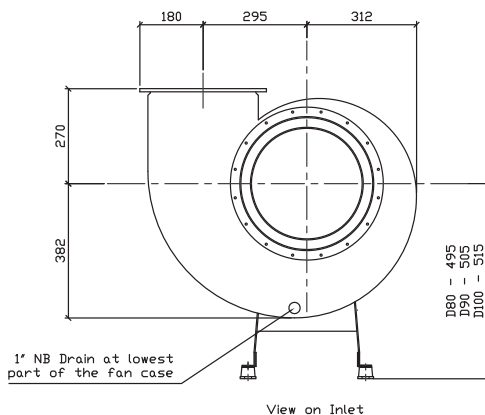
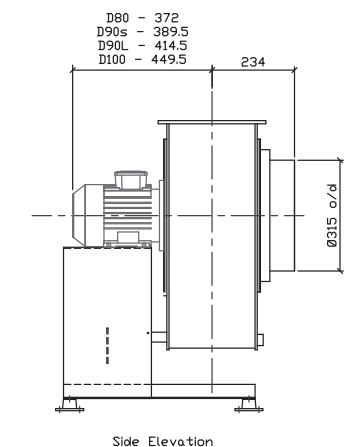

Angle of Discharge Shown - L90°

All measurements in mm

## All these features as standard

- Chemical resistant polypropylene centrifugal fan case with drain point
- Forward curved multi-vane moulded impeller manufactured from polypropylene
- Galvanised mild steel constructed pedestal with inlet support ring
- 4 off rubber anti-vibration mounts
- 3 phase motor with minimum IP55 enclosure
- Enclosure can be upgraded to meet customer requirements
- Directly driven unit
- Motors are IE1 or IE2 efficient as standard, depending on the speed rating
- IE3 efficient motors are also available on request

Fan Size	Motor Frame Size (mm)	Approximate Weight
AP315G	80	30
	90	38
	100	45

## Technical specification

- Recommended maximum operating temperature of 40°C
- Noise data available on request, please contact our technical office for further details

## Optional extras

- Inverter control 1ph to 3ph or 3ph to 3ph supply
- PVC inlet and outlet flexible connections
- Fabricated PVC or polypropylene outlet transformation duct sections
- Fabricated rectangular non-return dampers
- A range of PVC or polypropylene vent tube and fittings